

NEW
PRODUCT!

77mm Widespan Roller Shutter

Widespan Residential & Commercial Applications



This roller shutter range is made with a precision roll formed roller shutter profile, and is suitable for many widespan applications.

Suitable Applications

- Residential Garage Doors.
- Commercial Garage Doors.
- Commercial Windows.
- Commercial Shop Fronts & Doorways.
- Entry Level Security for Factories, Warehouses, Clubs, Pubs & Hotels, Restaurants, Pharmacies & Sports Complexes.

Features

- High quality aluminium alloy construction.
- Foam filled profile for additional strength, security and silent operation.
- High quality painted finish.
- Smooth and curved face profile.
- Rolls smaller than traditional steel roller doors.
- Range of colours.
- Double coated + lacquer for abrasion resistant finish.
- Comprehensively engineered for extra strength.
- Heavy duty guides and bottom bar.
- Fully enclosed pelmet with internal rollers and reinforcement side plates.
- Suitable for widespan widths up to 5900mm.
- Can be manually operated or motorised.
- Made in Australia.

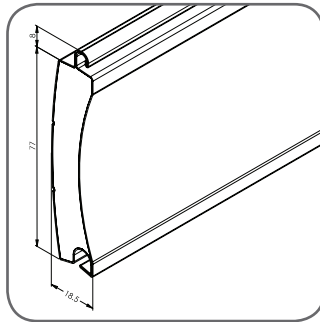
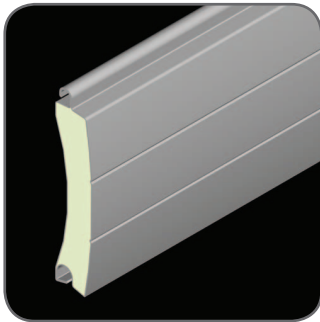

Technical Specifications

Maximum Shutter Width	5900mm
Maximum Shutter Height	3000mm
Maximum Surface Area	15m ² (depending on wind zone)
Weight/Metre ²	5kg
Number Of Slats/Metre	13
Profile Slat Covering	77mm
Profile Slat Thickness	18.5mm
Axle Types	Octagonal or Round Steel
Bottom Bar Dimensions	106mm x 19mm
Guide Dimensions	105mm x 37mm/26mm
Paint Finish	Polyurethane/Polyamide (PU/PA)
Inner Profile Foam Type	Poly Urethane (CFC Free)

* Shutter Components Australia recommends the use of Photo Safety Cells when installing automated roller shutters over openings and doorways. Especially when the roller shutter is not in full view of the operator (eg. when using a remote control or wall switch positioned away from the roller shutter and out of view). When using a wall switch, we recommend a spring return switch/deadman switch.





General Note: All dimensions and colours are indicative only and may change without notice. Profile technical specifications and shutter performance may vary in certain applications, eg. wide applications with no solid structure behind the roller shutter. For more information please contact Shutter Components Australia.



Pelmet Sizes & Maximum Shutter Height

Pelmet Box Size	Max. No. Of Slats	Max. Shutter Height	Axle Size
250mm	23	2000mm	101mm with adaptor
250mm	21	1800mm	130mm with adaptor
300mm	39	3200mm	101mm with adaptor
300mm	36	3000mm	150mm with adaptor

Roller Shutter Colour Options

Profiles	Pelmets/Side Frames/Guides/Bottom Bars
 White	 White
 Brown	 Brown
 Silver	Powder coated options available (additional charges apply)

Wind Speeds & Maximum Shutter Width

Wind Speed	Max. Shutter Width	Max. Surface Area
11.2m/sec	4400mm	13.23m ²
13m/sec	3520mm	10.56m ²
15.8m/sec	3060mm	9.18m ²
20.4m/sec	2670mm	8.01m ²

Control Options

Manual Options

Motorised Options



Steel Cable Winder
(Up To 50Kg)



Wall Switch
With 240V
Electric Motor



Remote Control
With 240V
Electric SIMU Hz
Motor



Key Switch
With 240V
Electric Motor



Crank Handle
With 240V
Electric Manual
Override Motor



S-05 Remote Control
(Key Ring Transmitter)
With 240V
Electric Motor
& Multi-Function
S-05 Radio Receiver
& Control Unit

For more information on the 77mm Widespan Roller Shutter, please contact your nearest dealer or visit www.shuttercomponentsaustralia.com.au!

Authorised Dealer:

Casey Screens and Shutters

Phone 8790 1462 Mobile 0425 843 313

www.caseyscreens.com.au

Illustrations, photos and colours shown in this brochure are for illustrative purposes only. All technical specifications and dimensions are correct at time of printing and may change without notice. Profile technical specifications and shutter performance may vary in certain applications, eg. wide applications with no solid structure behind the roller shutter. For more information please contact Shutter Components Australia. © 2015 CW Products.

Distributed In Victoria By

Shutter Components Australia

1/8 Waigani Avenue Ravenhall VIC 3023

Tel: 03 9038 8904 Fax: 03 8390 0966

Web: www.shuttercomponentsaustralia.com.au

Manufactured By

Distributed By

